

STB 71 STB 73 STB 75

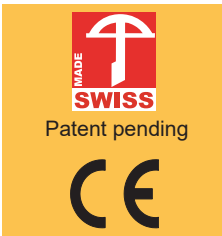

Battery-operated hand tool for plastic strapping



www.strapex-stb.com

Translation of original manual according to "Machine Directive" 2006/42/EEC.

Read the operating instructions carefully.

These operating instructions are part of the product and therefore should be kept for later use or a future owner.

Validity:

- STB 71 from Series no A/17020001
- STB 73 from Series no B/17020001
- STB 75 from Series no C/17020001

Manufacturer

Signode Switzerland GmbH
Silberstrasse 14, Postfach
8953 Dietikon 1
SWITZERLAND
signode.com



Table of contents

1	General information	4
2	Safety	5
2.1	Use for the intended purpose	5
2.2	Working safely	5
2.3	Safety instructions	5
2.4	General safety warnings for power tools	7
3	Description	9
3.1	Design	9
3.2	Function	10
3.3	Scope of delivery	10
3.4	Accessories	11
4	Preparing for operation and settings	12
4.1	Battery	12
4.2	Setting the operating mode	13
4.3	Setting strap tension	14
4.4	Setting soft tension	15
4.5	Setting welding time	15
4.6	Switching touch-pad lock on and off	15
4.7	Select Favorite	16
4.8	Sleep mode	16
5	Operating instructions	17
5.1	Strapping	17
5.2	Checking the seal	19
5.3	Setting the strap width	20
6	Preventive and corrective maintenance	23
6.1	Preventive maintenance schedule	23
6.2	Cleaning the tool	23
6.3	Re-greasing the tool	23
6.4	Cleaning/replacing the tension wheel	23
6.5	Cleaning/replacing the tooth plate	24
6.6	Replacing the knife	25
6.7	Tool reset	25
6.8	Troubleshooting	26
7	Technical data	27
8	EC Declaration of Conformity (copy)	28

Meaning of warning symbols, usage conventions



DANGER

Indicates a hazard with a high level of risk, which, if not avoided, will result in death or serious injury.



WARNING

Indicates a hazard with a moderate level of risk, which, if not avoided, may result in death or serious injury.



CAUTION

Indicates a hazard with a minor level of risk, which, if not avoided, may result in minor or moderate injury.



ATTENTION

Indicates a situation that can lead to material damage or poor operating results.



Indicates useful, supplementary information.

- ▶ This symbol identifies action steps.
 - This symbol indicates results from action steps.
- This symbol identifies list items.

Disposal and environmental protection

This tool is manufactured without any physical or chemical substances which could be dangerous to health.

It is important to protect health and also promote the reuse and environmentally-appropriate recycling of waste. The following harmonised standards have also been taken into consideration:

- Directive 2011/65/EU of 8 June 2011 on the restriction of the use of certain hazardous substances in electrical and electronic equipment (RoHS II).
- Directive 2012/19/EU of 4 July 2012 on waste electrical and electronic equipment (WEEE II).



The legal prescriptions for disposal of all parts must be observed.

- ▶ Chargers and batteries should be sorted for environmentally-friendly recycling.
- ▶ Observe notes, warnings and instructions of the battery manufacturer.

2

Safety

2.1 Use for the intended purpose

These tools are intended for the strapping of packaged items such as packages, pallet loads etc. The tools are intended for strapping with plastic packaging straps (polypropylene and polyester) (Section 7). Only use these tools as described in these operating instructions.

2.1.1 Possible misuse

- Do not use steel straps with these tools.
- Do not lift, hang or pull packaged goods by the straps.
- Do not modify tools without prior authorisation.
- Do not use these tools to compress goods.

2.2 Working safely

The operating instructions must always be available at the place of operation of the strapping tool. They must be read and observed by all persons working with or in the vicinity of the strapping tool.

Preventive and corrective maintenance on the tool may only be carried out by trained personnel.

In addition to the operating instructions, the applicable local rules for accident prevention and safe and professional work must be observed.



The operator or his supervisor is responsible for safe strapping and the correct strap selection (Section 7) for the package, depending on its dimensions, weight, edges and stability and the way it will be transported and stored. Only the strap specifications (Section 7) specified for the tool type should be used. The tools should be adjusted appropriately for the strap used and the package (Section 4). The operator is responsible for the correct tool settings and adjustments.

Wear protective equipment

- ▶ When operating the tool, wear eye and hand protection (cut-proof gloves) and safety shoes.



2.3 Safety instructions



WARNING

Read all safety warnings and all instructions in this operating instructions and in the battery charger operating instructions.

Failure to follow the warnings and instructions may result in electric shock, fire and/or serious injury. Following hazards can result in serious injuries:

Strap tensioning or strapping, danger of jamming and crushing

Do not place hands or other body parts between the strap and the packaged goods during the strapping process. Ensure that there are no other persons in the hazard zone (1).

For an emergency stop in the case of danger (trapped person):

- To release the strap tension (before welding), actuate the rocker lever. In operating mode AUTO, also the tensioning or welding button can be pressed again to stop strap tensioning.
- After welding, cut the strap using a suitable tool (strap cutter).

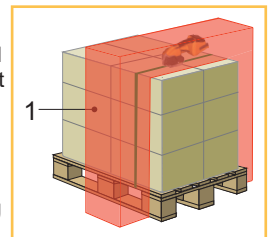



WARNING

Following hazards can result in injuries:

Loose and falling packaged goods in the case of faulty seal

Check the weld seal. Never transport packaged goods if loads look unbalanced or improper (Section 5.2).

Risk of explosion in EX (Explosive) zones

The tool must not be used in areas where explosions can occur as a result of the environment or products being used.

Moving parts of the tensioning device, risk of crushing

Do not grasp in the area of moving parts.

Breaking straps, risk of injury

When being tensioned the strap may break and whip out. Do not stand in line with the strap while it is being tensioned. Wear eye protection.

Strap ends snapping back, risk of injury

When cutting the strap, hold the upper portion and stand safely away from the strap. Do not stand in line with the strap while it is being tensioned. Wear eye protection.

Compressed air for cleaning work, risk of injury

When cleaning with compressed air, no air must penetrate the body via skin lesions. Use a blow gun with a multi hole nozzle. Wear eye protection.



CAUTION

The following dangers can result in minor or moderate injury:

Noise exposure

Wearing hearing protection is recommended.

Vibration exposure

The vibration level specified in these instructions has been measured according to a measurement method standardised in EN 60745 and can be used for the comparison of power tools with each other. It is also suitable for a preliminary estimation of the vibration load.

The vibration emission value measured may deviate from the specified value depending on the actual application, the strap used and the manner of operation. Under certain circumstances, the vibration load may be increased over the entire work period. For a more accurate assessment of the vibration load, the times should also be considered when the device is switched off, or is running but not actually being used. This could reduce the vibration load significantly over the entire work period.

Define additional safety measures against the effect of vibrations for the protection of the operator, such as, for example: maintenance of the power tool, keep hands warm and organisation of work processes.



ATTENTION

Avoid damage to the tool:

Water damage

Do not clean the tool with water or steam. When using the tool outdoors, protect it from rain.

Use only original spare parts

Using non-original spare parts will void the warranty and any liability.

2.4 General safety warnings for power tools



WARNING! Read all safety warnings and all instructions. Failure to follow the warnings and instructions may result in electric shock, fire and/or serious injury.

Save all warnings and instructions for future reference.

The term "power tool" in the warnings refers to your mains-operated (corded) power tool or battery-operated (cordless) power tool.

2.4.1 Work area safety

- a) **Keep the work area clean and well lit.** Cluttered or dark areas invite accidents.
- b) **Do not operate power tools in explosive atmospheres, such as in the presence of flammable liquids, gases or dust.** Power tools create sparks which may ignite the dust or fumes.
- c) **Keep children and bystanders away while operating a power tool.** Distractions can cause you to lose control.

2.4.2 Electrical safety

- a) **Power tool plugs must match the outlet. Never modify the plug in any way. Do not use any adapter plugs with earthed (grounded) power tools.** Unmodified plugs and matching outlets will reduce the risk of electric shock.
- b) **Avoid body contact with earthed or grounded surfaces such as pipes, radiators, ranges and refrigerators.** There is an increased risk of electric shock if your body is earthed or grounded.
- c) **Do not expose power tools to rain or wet conditions.** Water entering a power tool will increase the risk of electric shock.
- d) **Do not abuse the cord. Never use the cord for carrying, pulling or unplugging the power tool. Keep the cord away from heat, oil, sharp edges or moving parts.** Damaged or entangled cords increase the risk of electric shock.
- e) **When operating a power tool outdoors, use an extension cord suitable for outdoor use.** Use of a cord suitable for outdoor use reduces the risk of electric shock.
- f) **If operating a power tool in a damp location is unavoidable, use a residual current device (RCD) protected supply.** Use of an RCD reduces the risk of electric shock.

2.4.3 Personal safety

- a) **Stay alert, watch what you are doing and use common sense when operating a power tool. Do not use a power tool while you are tired or under the influence of drugs, alcohol or medication.** A moment of inattention while operating power tools may result in serious personal injury.
- b) **Use personal protective equipment. Always wear eye protection.** Protective equipment such as dust masks, non-skid safety shoes, hard hat, or hearing protection used for appropriate conditions will reduce personal injuries.
- c) **Prevent unintentional starting. Ensure the switch is in the off-position before connecting to the power source and/or battery pack, picking up or carrying the tool.** Carrying power tools with your finger on the switch or energising power tools that have the switch on invites accidents.
- d) **Remove any adjusting key or wrench before turning the power tool on.** A wrench or a key left attached to a rotating part of the power tool may result in personal injury.
- e) **Do not overreach. Keep proper footing and balance at all times.** This enables better control of the power tool in unexpected situations.
- f) **Dress properly. Do not wear loose clothing or jewellery. Keep your hair, clothing and gloves away from moving parts.** Loose clothes, jewellery or long hair can be caught in moving parts.
- g) **If devices are provided for the connection of dust extraction and collection facilities, ensure these are connected and properly used.** Use of dust collection can reduce dust-related hazards.

2.4.4 Power tool use and care

- a) **Do not force the power tool. Use the correct power tool for your application.** The correct power tool will do the job better and safer at the rate for which it was designed.
- b) **Do not use the power tool if the switch does not turn it on and off.** Any power tool that cannot be controlled with the switch is dangerous and must be repaired.
- c) **Disconnect the plug from the power source and/or the battery pack from the power tool before making any adjustments, changing accessories, or storing power tools.** Such preventive safety measures reduce the risk of starting the power tool accidentally.
- d) **Store idle power tools out of the reach of children and do not allow persons unfamiliar with the power tool or these instructions to operate the power tool.** Power tools are dangerous in the hands of untrained users.
- e) **Maintain power tools. Check for misalignment or binding of moving parts, breakage of parts and any other condition that may affect the power tool's operation. If damaged, have the power tool repaired before use.** Many accidents are caused by poorly maintained power tools.
- f) **Keep cutting tools sharp and clean.** Properly maintained cutting tools with sharp cutting edges are less likely to bind and are easier to control.
- g) **Use the power tool, accessories and tool bits etc. in accordance with these instructions, taking into account the working conditions and the work to be performed.** Use of the power tool for operations different from those intended could result in a hazardous situation.

2.4.5 Battery tool use and care

- a) **Recharge only with the charger specified by the manufacturer.** A charger that is suitable for one type of battery pack may create a risk of fire when used with another battery pack.
- b) **Use power tools only with specifically designated battery packs.** Use of any other battery packs may create a risk of injury and fire.
- c) **When the battery pack is not in use, keep it away from other metal objects, like paper clips, coins, keys, nails, screws or other small metal objects, that can make a connection from one terminal to another.** Shorting the battery terminals together may cause burns or a fire.
- d) **Under abusive conditions, liquid may be ejected from the battery; avoid contact. If contact accidentally occurs, flush with water. If liquid contacts eyes, additionally seek medical help.** Liquid ejected from the battery may cause irritation or burns.

2.4.6 Service

- a) **Have your power tool serviced by a qualified repair person using only identical replacement parts.** This will ensure that the safety of the power tool is maintained.

3

Description

3.1 Design

- 1 Tensioning button
- 2 Welding button
- 3 Handle
- 4 Rocker lever
- 5 Operating panel
- 6 Unlock button, battery
- 7 Battery
- 8 Type designation
- 9 Strap guide indicator
- 10 Serial number (XJJMMYYYY)
- X → A=STB 71, B=STB 73, C=STB75
- JJ → Year
- MM → Month
- YYYY → consecutive number
- 11 Welding device
- 12 Tensioning device

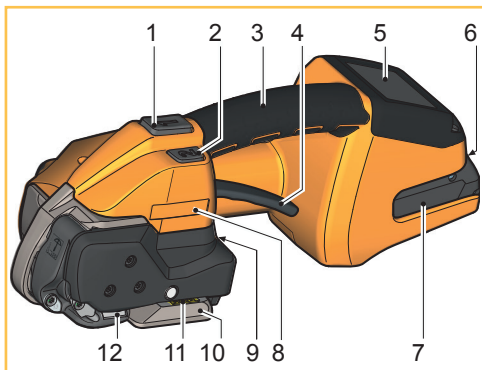



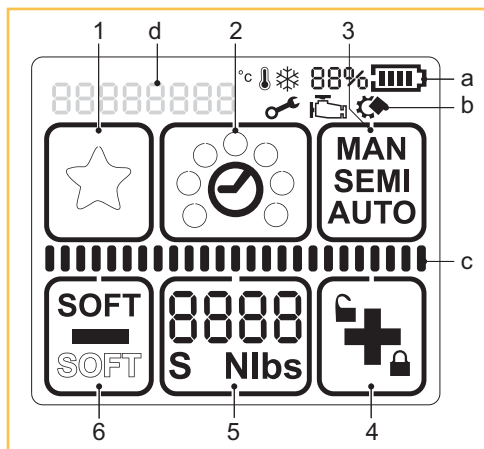

Operating panel

- 1 Keypad "Favourite"
- 2 Keypad "Welding time"
- 3 Keypad "Operating mode"
- 4 Keypad "Plus & Keylock"
- 5 Keypad "Tensioning force"
- 6 Keypad "Minus & Soft tension"
- a Display "Battery charge status"
- b Display "Information symbols"
- c Status indicator bar "Tensioning/Welding"
- d Display "Messages"



Background lighting

-  Display activated.
-  Welding process is finished, tool can be removed (Section 5.1).
-  Application error: temporary system error, can be rectified by the operator (Section 6.8).
-  Tool fault: static system error, rectify error (Section 6.8). If the error cannot be rectified → Service department.

Battery and charger

- 1 Charger
- 2 Battery
- 3 LED indicator



For detailed information, refer to the operating instructions for the battery and the charger.



3.2 Function

- The rocker lever is used to open the tensioning device so that the straps can be inserted.
- The straps are clamped between the tooth plate on the rocker (1) and the tension wheel (2).
- The strap is tensioned by the tension wheel (2) rotating in a counter-clockwise direction.
- The straps are welded in the welding device (3) using the friction welding process.
- The upper strap is cut off by the knife (4).

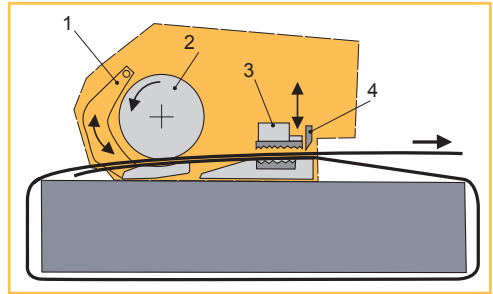

- You can choose between three operating modes: (Section 4.2)
 - Semi-automatic (standard/factory setting)
 - Fully automatic
 - Manual
- You can also choose between two tension ranges: (Section 4.3/4.4)
 - Standard tension for PET straps
 - Soft tension for PP straps (Tension wheel starts slowly. Prevents excessive dirt and grime build up in tool.)
- The welding time can be set. (Section 4.5)
- The tools can be operated with different strap widths (Section 7):
 - STB 71: 9–10 mm, 12–13 mm ($\frac{3}{8}$ " , $\frac{1}{2}$ ")
 - STB 73: 12–13 mm, 15–16 mm ($\frac{1}{2}$ " , $\frac{5}{8}$ ")
 - STB 75: 15–16 mm, 18–19 mm ($\frac{5}{8}$ " , $\frac{3}{4}$ ")

3.3 Scope of delivery

For strapping tool STB 71 / STB 73:

- Battery 18 V/2.0 Ah Li-Ion Part no 2187.011
 - Battery charger GAL 1880 CV EU Part no 2188.020
- or for USA version:
- Battery 18 V/2.0 Ah (US) BAT612 Part no 2187.012
 - Battery charger (US) BC1880 Part no 2188.021
- or for Japan version:
- Battery charger GAL 1880 CV (JP) Part no 2188.022
- or for Australia version:
- Battery charger GAL 1880 CV(AUS) Part no 2188.023

Tool kit consisting of:

- Wire brush Part no 1821.901.004
- Screwdriver Torx T20 Part no 1821.901.010
- Offset screwdriver Part no 1821.901.007

For strapping tool STB 75:

or for USA version:

or for Japan version:

or for Australia version:

Tool kit consisting of:

- Battery 18 V/4.0 Ah Li-Ion Part no 2187.003
- Battery charger GAL 1880 CV EU Part no 2188.020
- Battery 18 V/4.0 Ah (US) BAT620 Part no 2187.004
- Battery charger (US) BC1880 Part no 2188.021
- Battery charger GAL 1880 CV (JP) Part no 2188.022
- Battery charger GAL 1880 CV (AUS) Part no 2188.023

- Wire brush Part no 1821.901.004
- Screwdriver Torx T20 Part no 1821.901.010
- Offset screwdriver Part no 1821.901.007

3.4 Accessories

- Protection plate set
Part no 2189.010

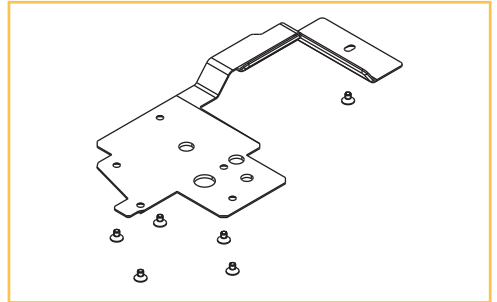

- Protection cover set
Part no 2189.011

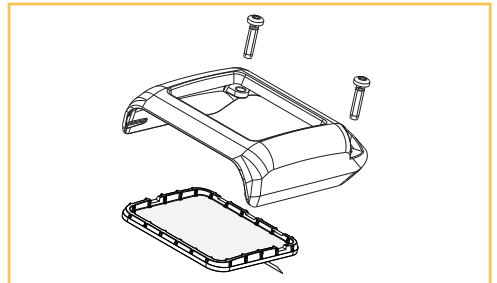

- Suspension bow set
Part no 2189.012

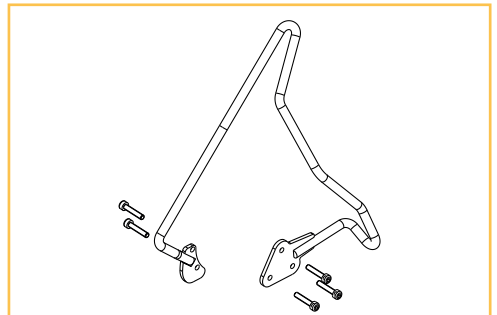

4

Preparing for operation and settings

4.1 Battery

For detailed information, see the separately enclosed operating instructions for the battery and the charger.



WARNING

Only use Bosch batteries and chargers as described in this manual (Section 3.3). Use of other batteries/chargers can result in injury or fire. To avoid the risk of personal injury or fire, read the battery charger operating instructions prior using the charger and battery.

4.1.1 Charging the battery

- ▶ Connect charger to mains.
 - Green LED illuminates (charger ready for use).
- ▶ Insert battery in charger.
 - Green LED flashes: Battery is being charged.
 - Green LED illuminates continuously: Battery is fully charged.
 - Red LED illuminates continuously: Battery temperature outside charge-temperature range.
 - Red LED flashes: see operating instructions of charger.



- Charging time: Charging of empty battery: approx. 15–35 min.
- Ideal battery temperature during charging process: 15–40 °C (59–104 °F)
- Avoid battery temperatures below 0 °C (32 °F) and over +45 °C (113 °F) during the charging process.
- The battery can be charged at any time, regardless of the charge status.

4.1.2 Inserting/removing battery in/from tool

- ▶ Inserting the battery: Insert the charged battery into the tool. The unlock button must engage in the second step (in the first step the battery is held in place in the tool, but without electrical contact).
 - The displays on the operating panel illuminate.
- If the tool is not used for approx. five minutes the display changes into sleep mode. Cancelling sleep mode: Lift rocker lever.
- If the tool is not used for a long period (days) the battery must be removed from the tool and charged/stored in the battery charger.
- ▶ Removing the battery: Press the unlock button and remove the battery at the same time.

4.1.3 Checking the charge status

- ▶ LED display "Battery charge status" on operating panel, with battery inserted:
 - The charge status is shown in % and by a progress bar (1)
 - Below 10% minimum charge (battery must be charged)
 - The information symbols (2) only appear if a corresponding situation is occurring (Section 6.8).

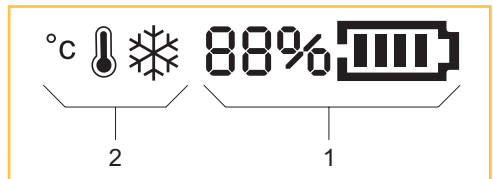

4.2 Setting the operating mode

- ▶ Press the "Operating mode" button (1).
 - Unused displays disappear.
 - The currently set operating mode flashes for 5 seconds.
 - + and – appear.
- ▶ Press the + (2) or – (3) button until the desired operating mode is displayed.
 - **MAN / SEMI / AUTO**
- ▶ By pressing the "Operating mode" button (1) again, or after waiting for a period of 5 seconds, the set mode is saved. Every operating mode can also be selected for the "Soft tension" tension range (Section 4.4).

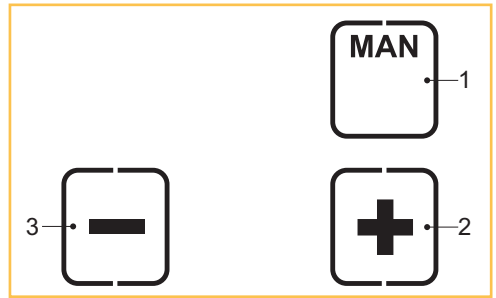

Select an operating mode for your application in accordance with the descriptions below: (The illustrations are symbolic. Actual use may deviate from these).

- **SEMI–Semi-automatic strapping (standard/factory setting)**

The tensioning button (Section 3.1) must be pressed and held down until the set tension force has been reached. The straps are then automatically welded and the upper strap is cut off. It can be welded manually at any time by pressing the welding button.

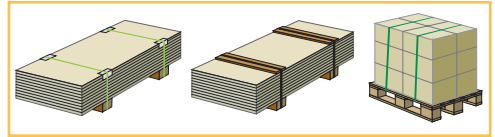

Recommended for similar packaged goods.

- **AUTO–Fully automatic strapping**

The tensioning button (Section 3.1) must only be briefly pressed (touched). This triggers the tensioning process. Once the set tension force has been reached, the straps are automatically welded and the upper strap is cut off.

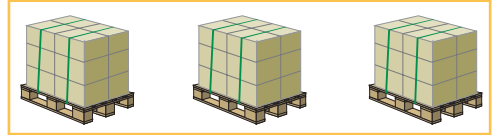

Recommended for large quantities of identical packaged goods.



WARNING

Strap tensioning or strapping, danger of jamming and crushing

Do not place hands or other body parts between the strap and the packaged goods during the strapping process. Ensure that there are no other persons in the hazard zone (Section 2.3).

For an emergency stop in the case of danger (trapped person):

To release the strap tension (before welding), actuate the rocker lever. In operating mode AUTO, also the tensioning or welding button can be pressed again. After welding, cut the strap using a tool (strap cutter).

- **MAN–Manual**

The tensioning button (Section 3.1) must be pressed and held down until the desired strap tension has been reached. The welding button (Section 3.1) must then be briefly pressed so that the straps are welded and the upper strap is cut off.

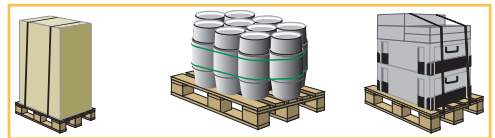

Recommended for varying (soft, hard) packaged goods.

4.3 Setting strap tension

The set tension force is displayed continuously when the tool is ready for operation.

- ▶ Press "Tension force" button (2).
 - The set tension force flashes for 5 seconds.
 - The + (1) and – (3) buttons appear.
 - Unused displays disappear.
- ▶ Press the + (1) or – (3) button until the desired tension force is displayed.
 - The status indicator bar (4) shows the set tension force in relation to the possible maximum value.
- ▶ Save: Press the "Tension force" button (2) or wait for 5 seconds.

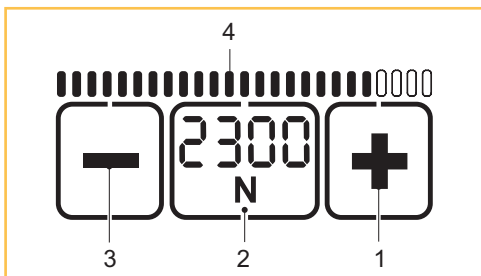

- Switch between display in "N" or "lbf": Press the flashing "Tension force" button (2) for two seconds.
- Every time the button is pressed an acoustic signal confirms the action.
- The tension force is displayed continuously when the tool is operational.
- Setting soft tension (Section 4.4).

STB 71:

		1	2	3	4	5	6	7	8	9
Standard:	N*	400	500	600	700	800	900	1000	1100	1200
	lbf*	90	110	135	155	180	200	225	250	270
Soft	N	150	225	300	375	450	525	600	675	750
	lbf	33	50	67	85	100	120	135	150	165

STB 73:

		1	2	3	4	5	6	7	8	9
Standard:	N*	900	1100	1300	1500	1700	1900	2100	2300	2500
	lbf*	200	250	290	340	380	430	470	520	560
Soft	N	400	520	640	760	880	1000	1120	1240	1360
	lbf	90	115	145	170	200	225	250	280	305

STB 75:

		1	2	3	4	5	6	7	8	9
Standard:	N*	1300	1700	2100	2500	2900	3300	3700	4100	4500
	lbf*	290	380	470	560	650	740	830	920	1000
Soft	N	400	550	700	850	1000	1150	1300	1450	1600
	lbf	90	120	160	190	225	260	290	325	360

(rounded values)

* N = Newton, lbf = pound-force per square inch

4.4 Setting soft tension

When soft tension is set the tension wheel starts more slowly and the tension force is reduced. This prevents excessive soiling when PP straps are used.

- ▶ Press "Soft" button (1).
 - The soft mode is **deactivated** when the "SOFT" display (2) changes position and is shown outlined.
- ▶ Press "Soft" button (1).
 - The soft mode is **activated** when the "SOFT" display (3) changes position and is shown in bold.
 - The displayed tension force is reduced correspondingly.
 - On the left under the tension force an "S" (4) also appears.

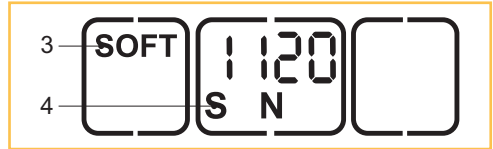
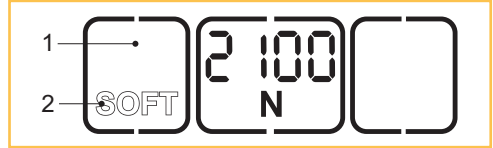

4.5 Setting welding time

The set welding time is displayed continuously by means of filled dots when the tool is ready for operation.

- ▶ Press the "Welding time" button (2).
 - Unused displays disappear.
 - The filled dots of the currently set welding time flash for 5 seconds.
 - + and – appear.
- ▶ Press the + (1) or – (3) button and hold down until the desired welding time is displayed.
- ▶ Save: Press the "Welding time" button (2) or wait 5 seconds.

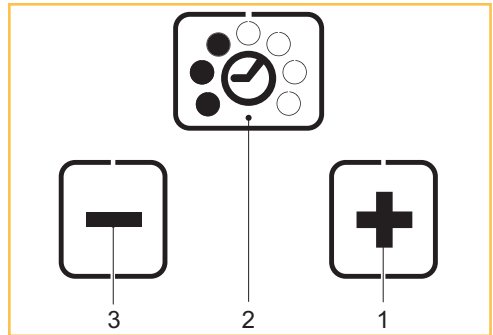

4.6 Switching touch-pad lock on and off

The touch pad can be locked to prevent unwanted changing of the settings.

- ▶ **Locking:** Press button "touch-pad lock" (1) for approx. 2 seconds, then press welding button (Section 3.1, pos. 2).
 - The lock symbol (2) changes position and is shown closed.
- ▶ **Unlocking:** Press button "touch-pad lock" (1) for approx. 2 seconds, then press welding button (Section 3.1, pos. 2).
 - The lock symbol (3) changes position and is shown open.



The favourite mode (Section 4.7) can be switched on even when the key lock is activated. If the adjustment of the settings is not desired, the favourite level should be set in the same way as the normal level.

4.7 Select Favorite

The "Favorite" function activates a second setting level whose parameters can be set freely as at the main level. This allows the user to switch quickly from one tool setting to another.

Activating Favorite:

- ▶ Press the "Favorite" button (1).
 - The star (2) changes from outlined to filled.
 - All parameters change to the values pre-set at this setting level.

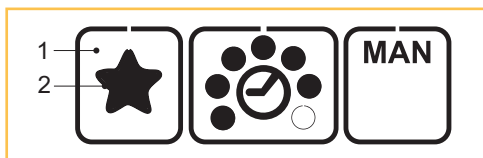

Deactivating Favorite:

- ▶ Press the "Favorite" button (1).
 - The star (3) changes from filled to outlined.
 - All parameters change to the values pre-set at this setting level.

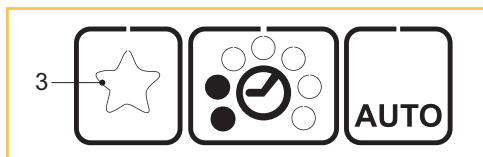

4.8 Sleep mode

To avoid unnecessary battery discharge, the tool switches to energy-saving mode within short time.

- The operating panel becomes dark (not illuminated).
- ▶ Pressing the operating panel switches the energy-saving mode off again.

After approx. five minutes without operation the tool switches to sleep mode.

- The operating panel is switched off (black).
- ▶ Actuating the rocker lever switches the sleep mode off again.

5.1 Strapping

Preconditions

- The tool is adjusted to the width of the strap to be used (Section 5.3).
- The charged battery is inserted (Section 4.1.2).
- The desired operating mode is set (Section 4.2.). In this description it is assumed that the selected operating mode (default mode) is "SEMI" (semi-automatic).
- Desired tension force is set (Section 4.3).
- Desired welding time is set (Section 4.5).

- ▶ Place the strap around the packaged goods.
- ▶ Grasp the straps at the top of the goods with your left hand so that:
 - The straps lie one above the other.
 - The beginning of the strap lies underneath and should project 15 cm (6") beyond your hand.

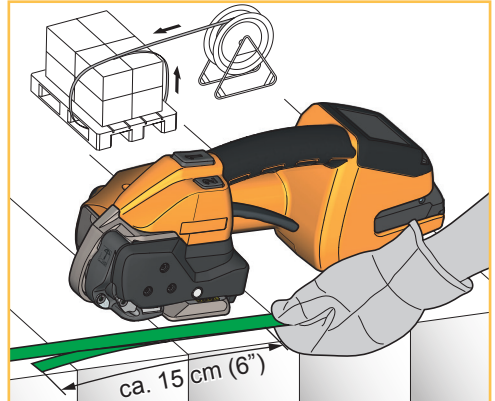

- ▶ Take the tool with your right hand.
- ▶ Lift rocker lever.
 - Rocker of the tensioning device opens.
- ▶ Insert overlaid straps up to the end stop. The strap coming from the dispenser lies above.
- ▶ Release rocker lever.
 - The straps are clamped in the tensioning device.
 - The beginning of the strap should project approx. 5 cm (2").

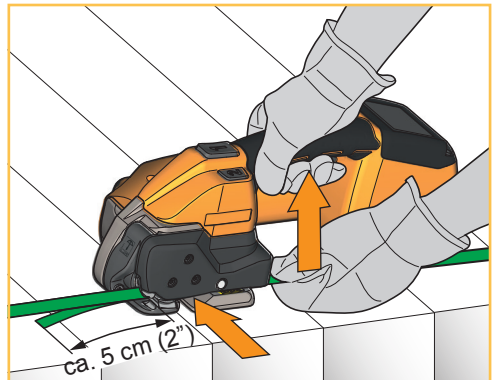

If the strap is not inserted completely, the strap guide indicator (Section 3.1, item 9) shows a red field. Insert the strap completely. The strap guide indicator is black.

- ▶ **Remove hands from the straps before tensioning!**



WARNING

Strap tensioning or strapping, danger of jamming and crushing

Do not place hands or other body parts between the strap and the packaged goods during the strapping process. Ensure that there are no other persons in the hazard zone (Section 2.3).

For an emergency stop in the case of danger (trapped person):

- To release the strap tension (before welding), actuate the rocker lever. In operating mode AUTO, also the tensioning or welding button can be pressed again.
- After welding, cut the strap using a tool (strap cutter).



CAUTION

When being tensioned the strap may break and whip out. Do not stand in line with the strap while it is being tensioned. Wear eye protection.

- ▶ Press the tensioning button and hold it down until the set tension force has been reached.



The tension speed is variable and depends on the pressure on the tensioning button (MAN/SEMI operating mode).

Stopping/continuing the tensioning process:
Release / press the tensioning button again.

- The following information is displayed:
The set tension force and the status indicator bar with the reached tension force in relation to the set tension force.
- The tensioning process is ended when the status indicator bar has been completely filled.

- ▶ The tensioning button can now be released.

- The straps are now automatically welded and the upper strap is cut off.
- The following information is displayed:
The set welding time and the status indicator bar.
- The welding process is ended when the status indicator bar has been completely filled (1.). After this the cooling time begins (2.). At the end of the cooling time an acoustic signal sounds and the operating panel lights up green for a second.

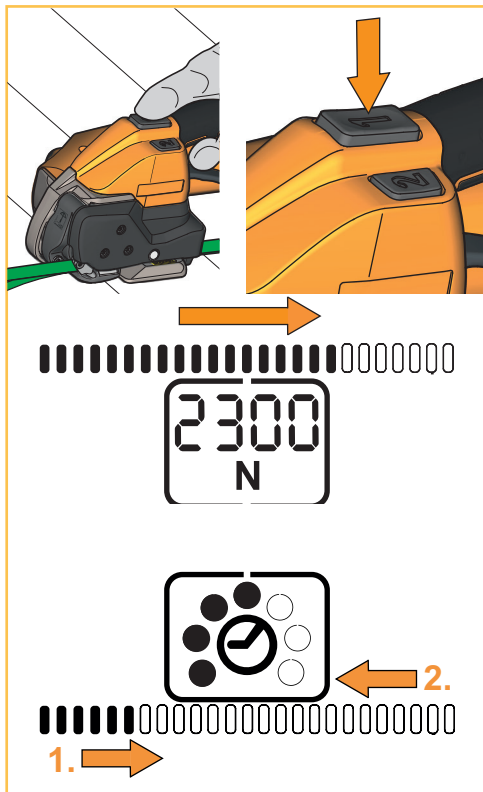

- Welding without strap tension: Press the tensioning button briefly, then press the welding button (Section 3.1, item 2).

- ▶ After the display turns green and an acoustic signal sounds the cooling time is ended. Lift rocker lever.
 - Rocker of the tensioning device opens.

 After lifting the rocker lever, do not re-tension (do not press the tensioning button any more).

- ▶ Swivel the tool to the right away from the strapping.

 **WARNING**
If the tool is removed too early the display turns orange with error code and an acoustic signal sounds repeatedly (Section 6.8).

- ▶ Carry out a visual sealing inspection (Section 5.2)

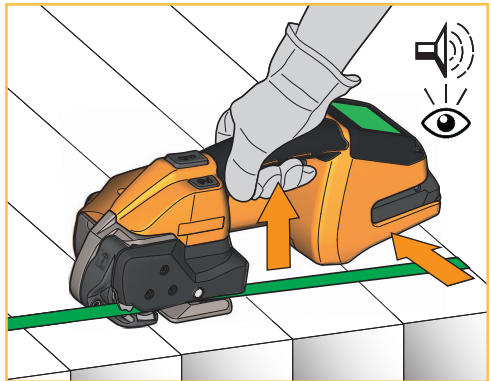

5.2 Checking the seal

 **WARNING**
Never transport or move packaged goods with improperly performed strapping / weld sealing - serious injuries may result.
Perform sealing check after each strapping.

- ▶ Perform sealing check by visual inspection.
- 1 **Good seal** (the entire sealing area has been cleanly welded, without excess material being forced out sideways).
 - 2 **Poorly welded seal** (weld not over entire sealing area), welding time too short.
 - 3 **Poorly welded seal** (excess material has been forced out sideways), welding time too long.

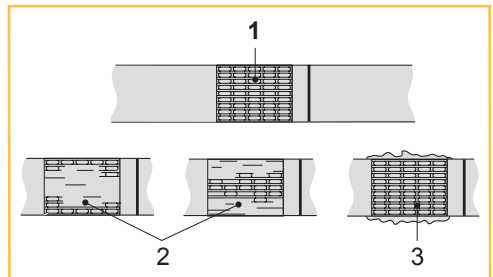

In the case of straps with poorly welded seals:

- ▶ Check the welding time setting (Section 4.5).
- ▶ Strapping with poorly welded seals must be performed again.
- ▶ Check strap type (Section 7).
- ▶ If good welding is not achieved, the tool must be checked by an authorized service center.

5.3 Setting the strap width

The tools can be operated with the following strap widths:

- STB 71: 9–10 mm, 12–13 mm ($\frac{3}{8}$ " , $\frac{1}{2}$ ")
- STB 73: 12-13 mm, 15-16 mm ($\frac{1}{2}$ " , $\frac{5}{8}$ ")
- STB 75: 15-16 mm, 18-19 mm ($\frac{5}{8}$ " , $\frac{3}{4}$ ")

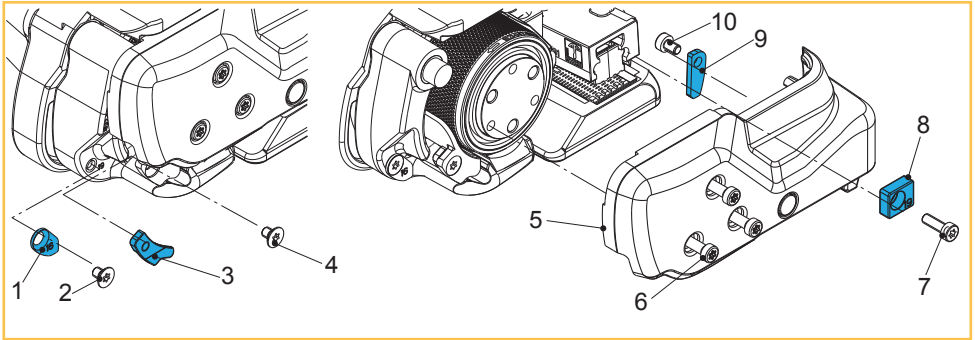

STB 75

5.3.1 STB 71: Change strap width from 9 mm to 13 mm ($\frac{3}{8}$ " to $\frac{1}{2}$ ")

Required parts	Order number
Strap guide front 13 mm ($\frac{1}{2}$ ") (3)	1832.031.051
Strap guide rear 13 mm ($\frac{1}{2}$ ") (8)	1832.041.019
Strap guide rear 13 mm ($\frac{1}{2}$ ") (9)	1832.042.043
Counter-sunk screw Torx, M4x6 (4)	1912.204.064

- ▶ Remove battery from tool. Remove three cylinder screws Torx (6). Lift rocker lever towards the handle, remove cylinder screw Torx (7) and strap guide rear 9 mm ($\frac{3}{8}$ ") (8).
- ▶ Remove side cover (5).
- ▶ Remove counter-sunk screw Torx (2) and strap guide front 9 mm (1).
- ▶ Remove counter-sunk screw Torx (4) and strap guide front 9 mm (3). Fit strap guide front 13 mm (3) (secure counter-sunk screw with Loctite 222).
- ▶ Remove cylinder screw Torx (10) and strap guide rear 9 mm (9). Fit strap guide rear 13 mm (9) (secure cylinder screw with Loctite 222).
- ▶ Fit side cover (5) (secure cylinder screw with Loctite 222). Install strap guide rear 13 mm (8).

STB 71: Change from 13 mm to 9 mm ($\frac{1}{2}$ " to $\frac{3}{8}$ ")

Required parts	Order number
Strap guide front 9 mm ($\frac{3}{8}$ ") (1)	1832.031.121
Strap guide front 9 mm ($\frac{3}{8}$ ") (3)	1832.031.046
Strap guide rear 9 mm ($\frac{3}{8}$ ") (8)	1832.041.020
Strap guide rear 9 mm ($\frac{3}{8}$ ") (9)	1832.042.047
Counter-sunk screw Torx, M4x6 (4)	1912.204.064
Counter-sunk screw Torx, M4x10 (2)	1912.204.108

- ▶ Remove battery from tool. Remove three cylinder screws Torx (6). Lift rocker lever towards the handle, remove cylinder screw Torx (7) and strap guide rear 13 mm ($\frac{1}{2}$ ") (8).
- ▶ Remove side cover (5).
- ▶ Fit strap guide front 9 mm (1) (secure counter-sunk screw (2) with Loctite 222).

- ▶ Remove counter-sunk screw Torx (4) and strap guide front 13 mm (3). Fit strap guide front 9 mm (3) (secure counter-sunk screw with Loctite 222).
- ▶ Fit strap guide rear 9 mm (9) (secure cylinder screw with Loctite 222).
- ▶ Fit side cover (5) (secure cylinder screw with Loctite 222). Install strap guide rear 9 mm (8).

5.3.2 STB 73: Change from 13 mm to 16 mm ($\frac{1}{2}$ " to $\frac{5}{8}$ ")

Required parts	Order number
Strap guide rear 16 mm ($\frac{5}{8}$ ") (8)	1832.041.018

- ▶ Remove battery from tool. Remove three cylinder screws Torx (6). Lift rocker lever towards the handle, remove cylinder screw Torx (7) and strap guide rear 13 mm ($\frac{1}{2}$ ") (8).
- ▶ Remove side cover (5).
- ▶ Remove counter-sunk screw Torx (2) and strap guide front 13 mm (1).
- ▶ Remove counter-sunk screw Torx (4) and strap guide front 13 mm (3).
- ▶ Remove cylinder screw Torx (10) and strap guide rear 13 mm (9).
- ▶ Fit side cover (5) (secure cylinder screw with Loctite 222). Install strap guide rear 16 mm (8).

STB 73: Change from 16 mm to 13 mm: ($\frac{5}{8}$ " to $\frac{1}{2}$ ")

Required parts	Order number
Strap guide front 13 mm ($\frac{1}{2}$ ") (1)	1832.031.116
Strap guide front 13 mm ($\frac{1}{2}$ ") (3)	1832.031.051
Strap guide rear 13 mm ($\frac{1}{2}$ ") (9)	1832.042.043
Strap guide rear 13 mm ($\frac{1}{2}$ ") (8)	1832.041.019
Counter-sunk screw Torx, M4x6 (2) (4)	1912.204.064
Cylinder screw Torx, M4x6 (10)	1913.904.064

- ▶ Remove battery from tool. Remove three cylinder screws Torx (6). Lift rocker lever towards the handle, remove cylinder screw Torx (7) and strap guide rear 16 mm ($\frac{5}{8}$ ") (8).
- ▶ Remove side cover (5).
- ▶ Fit strap guide front 13 mm (1) (secure counter-sunk screw with Loctite 222).
- ▶ Fit strap guide front 13 mm (3) (secure counter-sunk screw with Loctite 222).
- ▶ Fit strap guide rear 13 mm (9) (secure cylinder screw (10) with Loctite 222).
- ▶ Fit side cover (5) (secure cylinder screw with Loctite 222). Install strap guide rear 13 mm (8).

5.3.3 STB 75: Change from 16 mm to 19 mm ($\frac{5}{8}$ " to $\frac{3}{4}$ ")

Required parts	Order number
Strap guide rear 19 mm ($\frac{3}{4}$ ") (8)	1832.041.021

- ▶ Remove battery from tool. Remove three cylinder screws Torx (6). Lift rocker lever towards the handle, remove cylinder screw Torx (7) and strap guide rear 16 mm ($\frac{5}{8}$ ") (8).
- ▶ Remove side cover (5).
- ▶ Remove counter-sunk screw Torx (2) and strap guide front 16 mm (1).
- ▶ Remove counter-sunk screw Torx (4) and strap guide front 16 mm (3).
- ▶ Remove cylinder screw Torx (10) and strap guide rear 16 mm (9).
- ▶ Fit side cover (5) (secure cylinder screw with Loctite 222). Install strap guide rear 19 mm (8).

STB 75: Change from 19 mm to 16 mm ($\frac{3}{4}$ " to $\frac{5}{8}$ ")

Required parts	Order number
Strap guide front 16 mm ($\frac{5}{8}$ ") (1)	1832.031.117
Strap guide front 16 mm ($\frac{5}{8}$ ") (3)	1832.031.067
Strap guide rear 16 mm ($\frac{5}{8}$ ") (9)	1832.042.048
Strap guide rear 16 mm ($\frac{5}{8}$ ") (8)	1832.041.022
Counter-sunk screw Torx, M4x6 (2) (4)	1912.204.064
Cylinder screw Torx, M4x6 (10)	1913.904.064

- ▶ Remove battery from tool. Remove three cylinder screws Torx (6). Lift rocker lever towards the handle, remove cylinder screw Torx (7) and strap guide rear 19 mm ($\frac{3}{4}$ ") (8).
- ▶ Remove side cover (5).
- ▶ Fit strap guide front 16 mm (1) (secure counter-sunk screw with Loctite 222).
- ▶ Fit strap guide front 16 mm (3) (secure counter-sunk screw with Loctite 222).
- ▶ Fit strap guide rear 16 mm (9) (secure cylinder screw (10) with Loctite 222).
- ▶ Fit side cover (5) (secure cylinder screw with Loctite 222). Install strap guide rear 16 mm (8).

6

Preventive and corrective maintenance



WARNING

Unexpected startup during maintenance work, injuries possible.

Always remove the battery before performing cleaning or preventive and corrective maintenance work.

6.1 Preventive maintenance schedule

Task	Interval (cycles)
Cleaning the tool (Section 6.2)	– Daily (for > 300 strappings/day) – Weekly (for 100-300 strappings/day)
Re-greasing the tool (Section 6.3)	– Monthly (for 100-300 strappings/day)
Tool inspection (recommended)	– Every 2 years or 80,000 strappings, service by specialist unit

6.2 Cleaning the tool

In the case of heavy dirt accumulation it is recommended that the tool be cleaned regularly (daily). In particular, the tension wheel and the tooth plate should be checked for damage and kept clean.



WARNING

Wear eye protection when cleaning with compressed air!

- ▶ In the rear housing shell beneath the motor the tool has an access hole (Ø 3 mm) through which the welding device is first blown out with compressed air.
- ▶ After this, clean the tension wheel and toothed plate with compressed air by blowing them out from the sides.
- ▶ If necessary, clean/replace the tension wheel / tooth plate (Section 6.4/6.5).

6.3 Re-greasing the tool

To ensure optimal stability it is recommended that the tool be re-greased regularly.

- ▶ Remove battery from tool. Remove four cylinder screws Torx (2), strap guide rear (3) and side cover (4).
- ▶ Carefully spray welding device at the two points (5) with a high-pressure-resistant adhesive lubricating oil spray (e.g. Würth HHS 2000).
- ▶ Below at the base plate, remove counter-sunk screw Torx (1) and also spray into the lubrication hole with the same spray. **Refit the counter-sunk screw (1).**
- ▶ Refit the side cover (4).

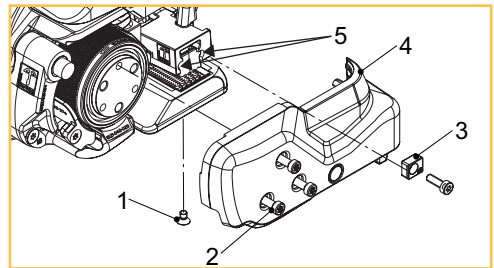

STB 75

6.4 Cleaning/replacing the tension wheel

Required parts	Order number
STB 71 / STB 73: Tension wheel (1) (wear part)	1821.047.033
STB 75: Tension wheel (1) (wear part)	1821.047.036
Ball bearing, Ø35/47x7 (2)	1930.180.356
Cylinder screw Torx, M4 (4)	1821.027.063
Wire brush (6)	1821.901.004

Dismantling

- ▶ Remove battery from tool. Remove four cylinder screws Torx (4), strap guide rear (5) and side cover (3).
- ▶ Carefully pull out tension wheel (1).
- ▶ Remove ball bearing (2) from tension wheel.



WARNING

Wear eye protection when cleaning with compressed air!

- ▶ Clean tension wheel (1) with compressed air.
- ▶ In the case of heavy soiling of the toothing: Carefully clean tension wheel with enclosed wire brush (6).
- ▶ Check tension wheel for worn teeth. If teeth are worn, replace tension wheel.

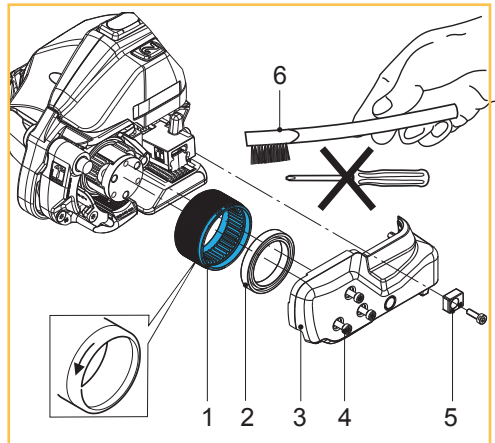

STB 75



Attention

The tension wheel must not be cleaned while it is rotating. Risk of tooth breakage!

Fitting

- ▶ Fitting is performed in reverse order. Observe the direction of rotation of the tension wheel, see arrow.
- ▶ Lightly lubricate the inner teeth of the tension wheel with Klüber grease GBU Y 131 (Microlube).

6.5 Cleaning/replacing the tooth plate

Required parts	Order number
STB 71 / STB 73: Tooth plate (2) (wear part)	1821.048.026
STB 75: Tooth plate (2) (wear part)	1821.048.030
Torx counter-sunk screw Torx (1)	1832.039.285
Wire brush (3)	1821.901.004

Dismantling

- ▶ Remove battery from tool.
- ▶ Remove counter-sunk screw Torx (1).
- ▶ Lift rocker lever towards the handle, remove tooth plate (2).



WARNING

Wear eye protection when cleaning with compressed air!

- ▶ Clean tooth plate (2) with compressed air.
- ▶ In the case of heavy soiling of the teeth: Carefully clean tooth plate with enclosed wire brush (3).
- ▶ Check tooth plate for worn teeth. If several teeth are worn, replace tooth plate.

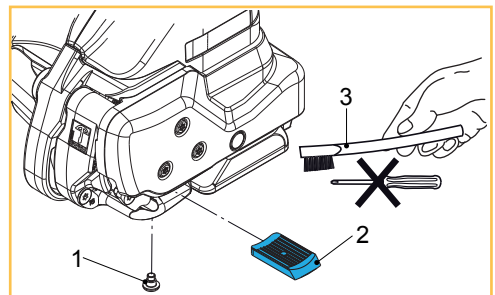

Fitting

- ▶ Fitting is performed in reverse order. Secure counter-sunk screw (1) with Loctite 222.
 - The tooth plate (2) must sit freely movable in the rocker.

6.6 Replacing the knife

Required parts	Order number
STB 71 / STB 73: Knife (1) (wear part)	1821.209.036
STB 75: Knife (1) (wear part)	1821.209.040
Cylinder screw Torx, M4 (3)	1821.027.063
Cylinder screw Torx, M4x12 (5)	1913.904.125
Flanged bushing (6)	1832.022.238

Dismantling

- ▶ Remove battery from tool.
- ▶ Remove four cylinder screws Torx (3), strap guide rear (4) and side cover (2).
- ▶ Remove cylinder screw Torx (5) and knife (1) with flanged bushing (6). Replace knife.

Fitting

- ▶ Fitting is performed in reverse order.
- ▶ Before fitting the knife (1), check whether the pressure spring (7) above the knife is inserted.
- ▶ Secure cylinder screw (5) with Loctite 222.

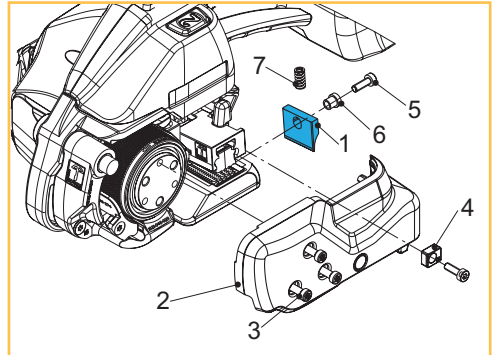

STB 75

6.7 Tool reset



Attention

The tool reset may only be performed if the rocker lever is blocked. **Never attempt to lift the rocker lever by force!**

- ▶ Place the enclosed 3 mm hex. socket-head key (1) through the bore hole in the base plate directly onto the cylinder screw located underneath (see arrow).
- ▶ **Perform ten full rotations in the counter-clockwise direction.** This requires a little physical effort.
- ▶ Lift rocker lever (2).
 - The welding mechanism should now pivot upwards.

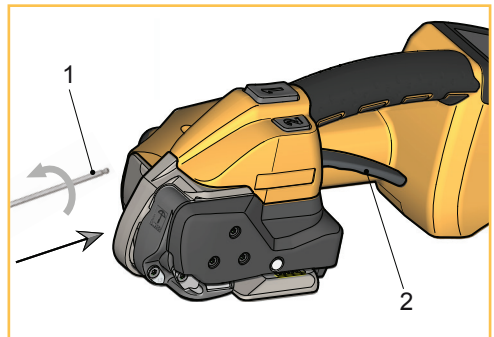

























If the tool reset could not be carried out successfully, please contact the Service Centre!

6.8 Troubleshooting

If certain errors occur, the background lighting of the operating panel and the fault display (symbol + code) illuminate, and an acoustic signal sounds.

If the error is still pending (is not reset automatically), acknowledge by removing / inserting the battery.

Display / state	Probable cause	Remedy / Corrective action
Operating panel does not react + 	<ul style="list-style-type: none"> Button lock is switched on. 	<ul style="list-style-type: none"> Switch off button lock: see Section 4.6.
Display remains dark.	<ul style="list-style-type: none"> Battery faulty / fully discharged. Battery not properly inserted. 	<ul style="list-style-type: none"> Charge/replace battery. Check whether battery is completely inserted and unlocking device engaged.
E11, red display +  pulsating (long) Symbol flashes	<ul style="list-style-type: none"> Inserted battery not permitted (wrong battery). 	<ul style="list-style-type: none"> Insert correct battery.
E20, red display +  pulsating (long) Symbol flashes  & °C 	<ul style="list-style-type: none"> Battery too hot (> 60°C/140°F). 	<ul style="list-style-type: none"> Allow battery to cool. Charge battery, replace if necessary.
Symbols  &  flashing	<ul style="list-style-type: none"> Battery temperature too low. 	<ul style="list-style-type: none"> At a higher battery temperature it recovers by itself. Work possible. Max. strap tension is not reached.
E24, red display +  pulsating (long) Symbol flashes 	<ul style="list-style-type: none"> Battery not properly inserted. Wrong battery. 	<ul style="list-style-type: none"> Insert battery properly. Charge battery, replace if necessary.
E25, red display +  pulsating (long). Symbols °C  &  flashing	<ul style="list-style-type: none"> Battery not properly inserted. Temperature sensor faulty. 	<ul style="list-style-type: none"> Insert battery properly. Replace if necessary.
E27 (E23), red display +  pulsating (long) Symbol flashes 	<ul style="list-style-type: none"> Battery undervoltage limits reached. Battery empty. 	<ul style="list-style-type: none"> Charge battery, replace if necessary.
E33, red display +  pulsating (long) Symbol °C 	<ul style="list-style-type: none"> Electronics overtemperature. Controller too hot. 	<ul style="list-style-type: none"> Allow tool to cool.
E37, orange display +  pulsating (medium) Symbol 	<ul style="list-style-type: none"> Tool jams during welding process, dirty welding mechanism or foreign body in tool. 	<ul style="list-style-type: none"> Clean welding mechanism.
E50/51 orange display +  pulsating (medium) Symbol 	<ul style="list-style-type: none"> Aborting of welding or cooling process by lifting the rocker lever. 	<ul style="list-style-type: none"> Repeat strapping.
E57 orange display +  pulsating (medium) Tension force display flashes.	<ul style="list-style-type: none"> Strap slipped or broken. 	<ul style="list-style-type: none"> Reinsert strap. Check: Tension force, dirty strap, right strap and state of tension wheel / tooth plate.
E55/56 orange display +  pulsating (medium) Symbols °C  & 	<ul style="list-style-type: none"> Aborting of tensioning process. Performance limitation or time out. 	<ul style="list-style-type: none"> Repeat tensioning.

In the case of other error numbers not described here, please contact the the local service center. If the error cannot be rectified by applying the measures described above, please contact the local service center!

	STB 71	STB 73	STB 75
Weight	3.6 kg (7.9 lb) (incl. battery)	3.8 kg (8.4 lb) (incl. battery)	4.3 kg (9.5 lb) (incl. battery)
Dimensions	Length 370 mm/14.5" Width 141 mm/5.5" Height 135 mm/5.3"	Length 370 mm/14.5" Width 141 mm/5.5" Height 135 mm/5.3"	Length 370 mm/14.5" Width 143 mm/5.6" Height 135 mm/5.3"
Strap tension	400–1200 N (90–270 lbf) Soft: 150–750 N (22–165 lbf)	900–2500 N (200–560 lbf) Soft: 400–1360 N (90–305 lbf)	1300–4500 N (290–1000 lbf) Soft: 400–1600 N (90–340 lbf)
Tension speed	0–290 mm/s (11.3 in/s)	0–220 mm/s (8.6 in/s)	0–120 mm/s (4.7 in/s)
Sealing	Friction weld	Friction weld	Friction weld
Typical measured A-rated emission sound pressure level – EN ISO 11202 – EN 60745-1/2:2009	L _{pA} 79 dB (A) L _{pAeq} 77 dB (A)	L _{pA} 78 dB (A) L _{pAeq} 82 dB (A)	L _{pA} 79 dB (A) L _{pAeq} 81 dB (A)
Average sound power level – EN 60745-1/2:2009	LW ^{Aeq} 88 dB (A)	LW ^{Aeq} 93 dB (A)	LW ^{Aeq} 92 dB (A)
Deviation K	3.0 dB (A)	3.0 dB (A)	3.0 dB (A)
Vibrations at handle* – EN 60745-1/2:2009	a _h 2.4 m/s ² 1.5 m/s ²	a _h 2.4 m/s ² 1.5 m/s ²	a _h 2.3 m/s ² 1.5 m/s ²
Operating temperature for the strapping tool (See separate operating instructions for battery and charging device)	–10 °C to +40 °C (14–104 °F)	–10 °C to +40 °C (14–104 °F)	–10 °C to +40 °C (14–104 °F)
Relative humidity	Up to 90 %	Up to 90 %	Up to 90 %
CHARGER / BATTERY			
Rated voltage charger	100 / 110 / 230 V	100 / 110 / 230 V	100 / 110 / 230 V
Charger type	BOSCH GAL 1880 CV	BOSCH GAL 1880 CV	BOSCH GAL 1880 CV
Charging time	15–30 minutes, after 15 min. approx. 80% charging capacity	15–30 minutes, after 15 min. approx. 80% charging capacity	25–35 minutes, after 25 min. approx. 80% charging capacity
Strappings with one battery charge	400–800 depending on strap, strap tension and package	200–800 depending on strap, strap tension and package	300–800 depending on strap, strap tension and package
Battery	18 V/2.0 Ah, Li-Ion BOSCH	18 V/2.0 Ah, Li-Ion BOSCH	18 V/4.0 Ah, Li-Ion BOSCH



* refer to Section 2.3, Vibration exposure

Continued on the next page

Continuation:

	STB 71	STB 73	STB 75
PLASTIC STRAP			
Strap type	Polyester (PET) Polypropylene (PP)	Polyester (PET) Polypropylene (PP)	Polyester (PET) Polypropylene (PP)
Strap width adjustable to	9–10, 12–13 mm (³ / ₈ ", ¹ / ₂ ")	12–13, 15–16 mm (¹ / ₂ ", ⁵ / ₈ ")	15–16, 18–19 mm (⁵ / ₈ ", ³ / ₄ ")
Strap thickness	0.40–0.80 mm (PET) (.015"–.031") 0.50–0.80 mm (PP) (.019"–.031")	0.5–1.0 mm (.019"–.040")	0.8–1.3 mm (.031"–.051")

8 EC Declaration of Conformity (copy)

(CE 2006/42/EC, Annex II 1.A.)

The manufacturer take sole responsibility for declaring that the machines to which this declaration refers are in full conformity with the current requirements of the Council Directive of 17th May 2006 (2006/42/EC) "Machine Directive" and its amendments.

Furthermore, electrical installations are in conformity with the requirements of the Council Directive of 26th February 2014 (2014/30/EU) "EMC Directive".

The following harmonised standards were taken into account:

EN 60745-1:2009 + A11:2010; EN 60745-2-18:2009; EN ISO 12100:2011; EN 349:2008; EN 61000-6-1; EN 61000-6-3

EEC-Design certification:

No. M8A 17 03 28456 006

Place of certification:

TÜV SÜD Product Service GmbH

Type designations:

STB 71, STB 73, STB 75

From machine no./ year of construction: A/17020001, B/17020001, C/17020001 / 2017

CH-8953 Dietikon, 03.08.2020

U. Schweizer
General Manager

M. Binder
Director–Head of Global R&D

Agent for the publication of technical documentation:

Signode Switzerland GmbH, Silberstrasse 14, 8953 Dietikon 1, Switzerland

Manufacturer

Signode Switzerland GmbH
Silberstrasse 14, Postfach
8953 Dietikon 1
SWITZERLAND
signode.com